

TECHNICAL DRAWING

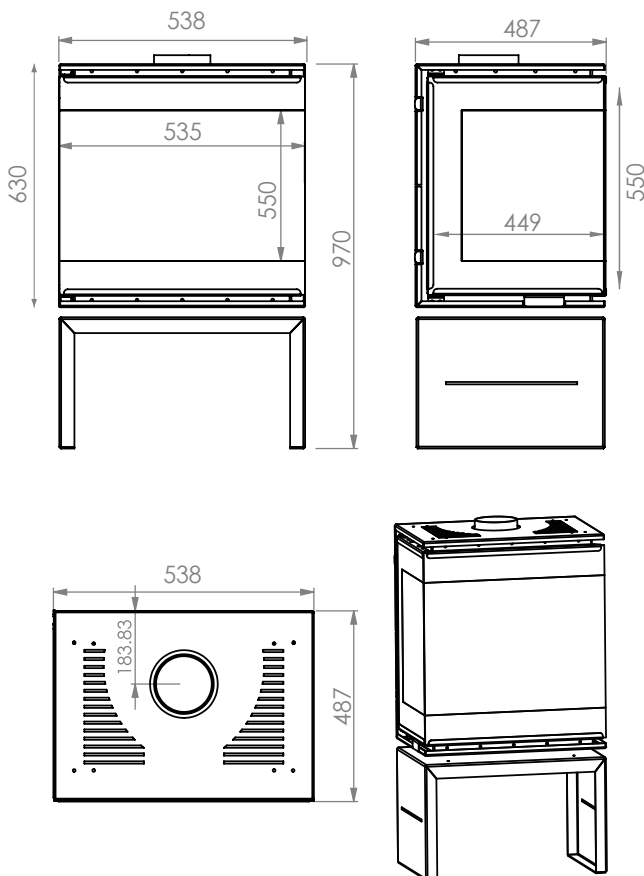

TECHNICAL SPECIFICATION

WEIGHT	96 KG
POWER	5-9KW
EFFICIENCY	> 75 %
CONSUME	2 - 3.5 kg/h
FLUE GAS TEMPERATURE	222° C
PIPE DIAMETER	Ø 180 mm
CO	< 1250 mg/m ³
WARRANTY	5 years

DIMENSIONS

Height	970 mm
Depth	487 mm
Width	538 mm